

TRIM ACCESSORIES

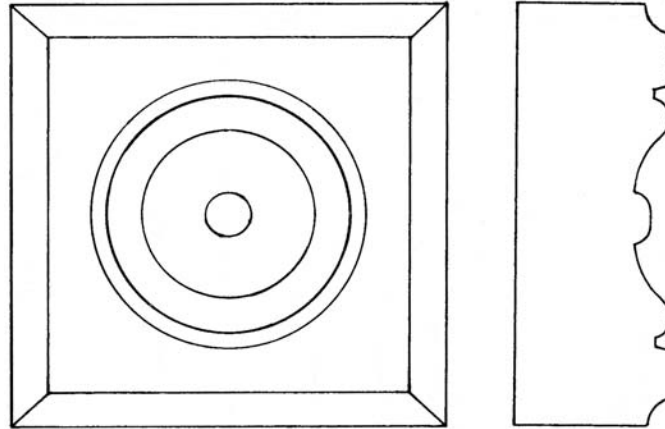

CORNER BLOCKS

AC1-3.12

3 $\frac{1}{8}$ " x 3 $\frac{1}{8}$ "

AC1-3.87

3 $\frac{7}{8}$ " x 3 $\frac{7}{8}$ "

AC1-4.125

4 $\frac{1}{8}$ " x 4 $\frac{1}{8}$ "

TRIM ACCESSORIES

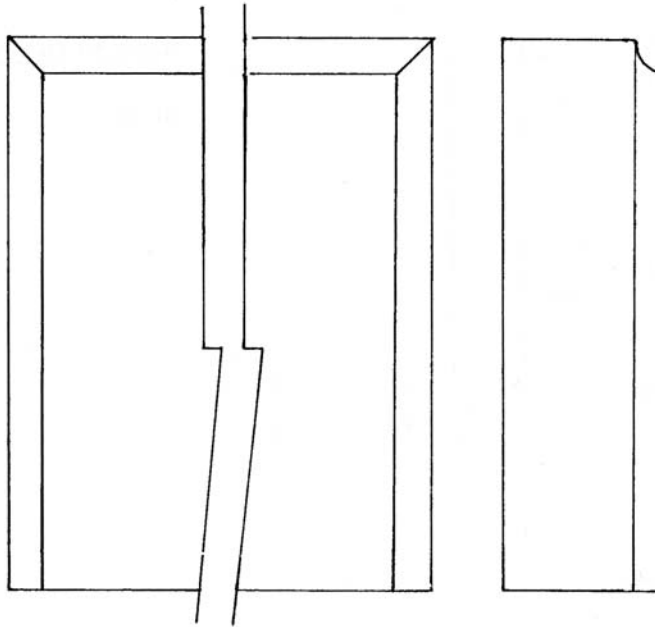

CORNER BLOCKS

- AC4-3.1
1 1/8" x 3 1/8" x 4 1/2"
- AC5-3.1
1 1/8" x 3 1/8" x 5 1/4"
- AC6-3.1
1 1/8" x 3 1/8" x 6 1/4"
- AC7-3.1
1 1/8" x 3 1/8" x 7 1/2"
- AC8-3.8
1 1/8" x 3 7/8" x 4 1/2"
- AC9-3.8
1 1/8" x 3 7/8" x 5 1/4"
- AC10-3.8
1 1/8" x 3 7/8" x 6 1/4"
- AC11-3.8
1 1/8" x 3 7/8" x 7 1/2"
- AC12-5.0
1 1/8" x 5" x 4 1/2"
- AC13-5.0
1 1/8" x 5" x 5 1/4"
- AC14-5.0
1 1/8" x 5" x 6 1/4"

TRIM ACCESSORIES

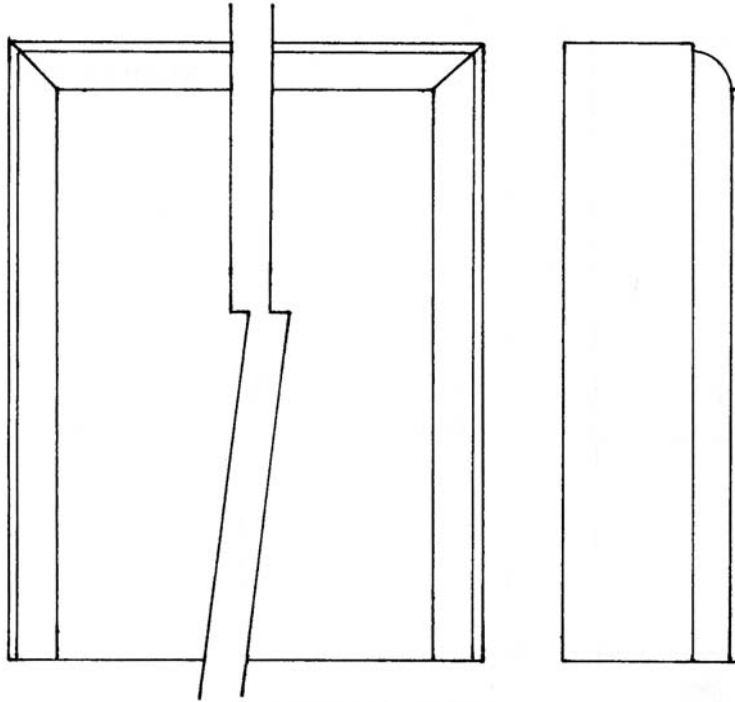

BASE BLOCKS

AC15-?

1/8" x ____" x ____"

TRIM ACCESSORIES

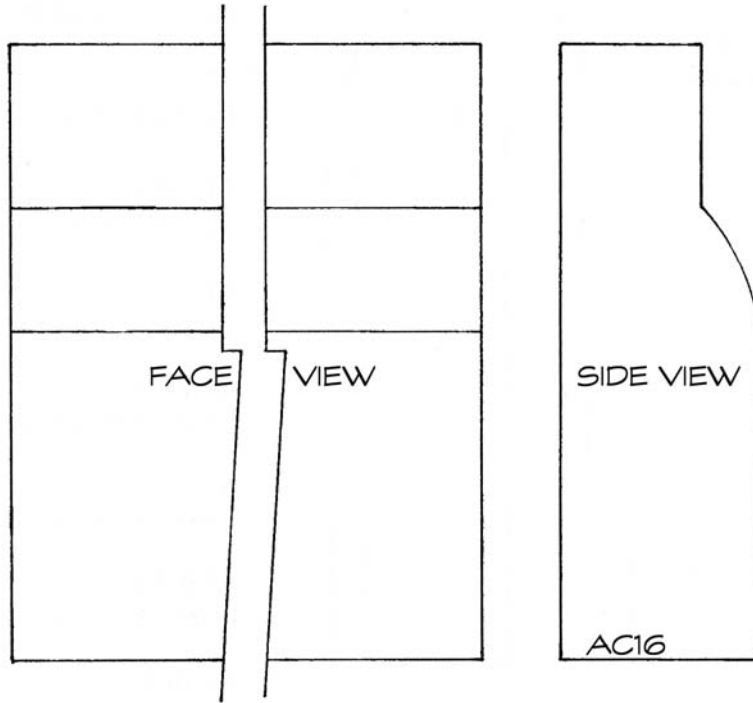

TRIM ACCESSORIES

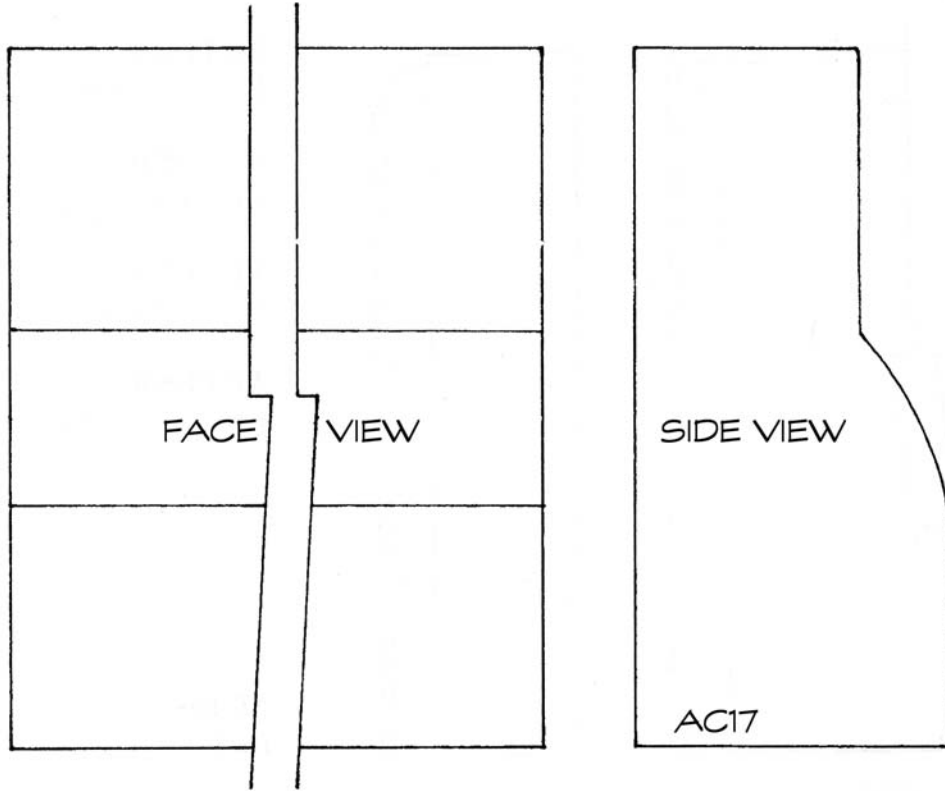

TRIM ACCESSORIES

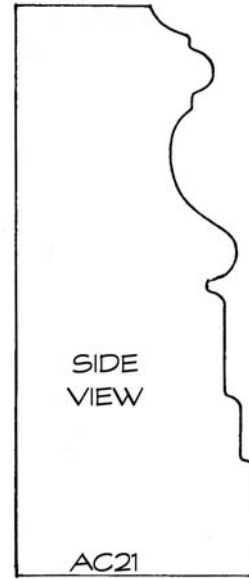
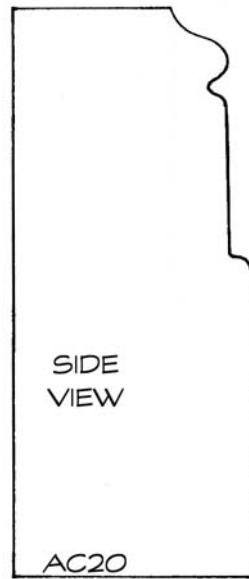
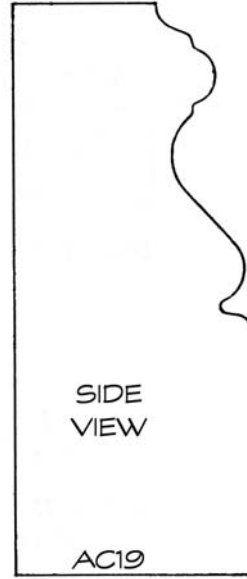
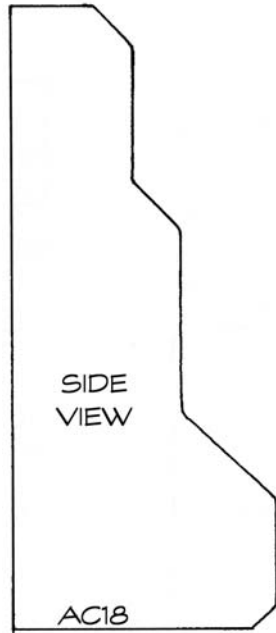

TRIM ACCESSORIES

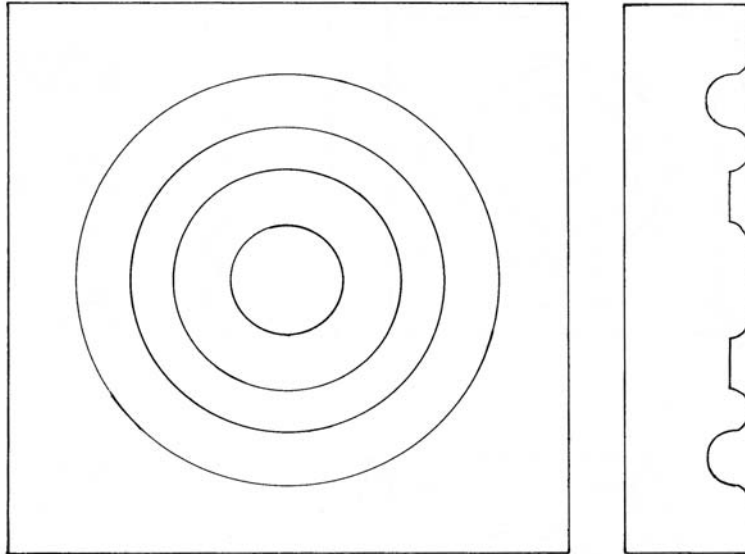

CORNER BLOCKS
AC3-5.0
5" x 5"



SIDE
VIEW

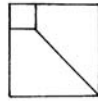

TOP VIEW

PLINTH BLOCKS

- AC22-5.0
7/8" x 7/8" x 5"
- AC23-6.25
7/8" x 7/8" x 6 1/4"
- AC24-7.0
7/8" x 7/8" x 6 1/4"
- AC25-7.5
7/8" x 7/8" x 6 1/4"



SIDE
VIEW

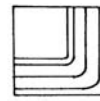

TOP VIEW

INSIDE CORNERS

- AC26-6.25
7/8" x 7/8" x 6 1/4"
- AC27-9.0
7/8" x 7/8" x 9"

TRIM ACCESSORIES

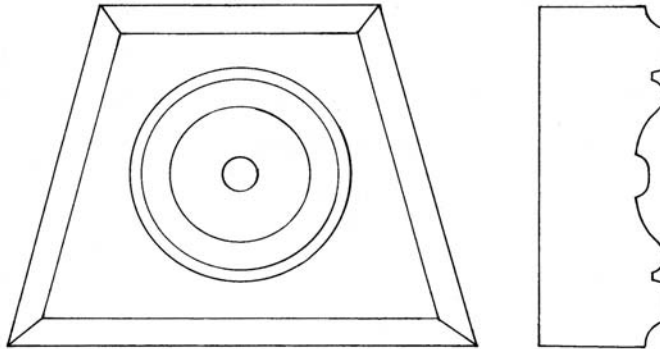

KEY BLOCKS

AC2-3.12

3 $\frac{1}{8}$ "

AC2-3.87

3 $\frac{7}{8}$ "

AC2-4.125

4 $\frac{1}{8}$ "

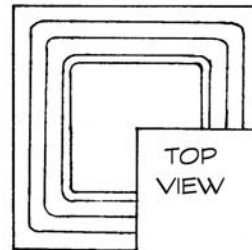

OUTSIDE CORNERS

AC28-6.25

1 $\frac{3}{4}$ " x 1 $\frac{3}{4}$ " x 6 $\frac{1}{4}$ "

AC28-9.0

1 $\frac{3}{4}$ " x 1 $\frac{3}{4}$ " x 9"

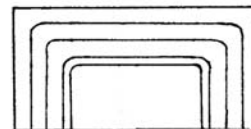

JOINER BLOCKS

AC30-6.25

1 $\frac{3}{4}$ " x 7 $\frac{1}{8}$ " x 6 $\frac{1}{4}$ "

AC31-9.0

1 $\frac{3}{4}$ " x 7 $\frac{1}{8}$ " x 9"

TRIM ACCESSORIES

